

---

# GUIDE TO GOOD AUDIO IN DISTANCE LEARNING



## CONTENTS

I.	Introduction.....	2
II.	It's (Almost) All in The Acoustics.....	3
III.	Correct Microphone Usage.....	5
IV.	Correct Loudspeaker Usage.....	8
V.	Acoustic Echo.....	9
VI.	Background Noise.....	12
VII.	Transmission Echo.....	13
VIII.	Sound System Problems.....	17
IX.	Telephone Audio Problems.....	18
X.	Summary.....	20
	About ASPI Digital.....	20

This PDF file is also available in printed form. Contact ASPI Digital for a copy.



## INTRODUCTION

If you're like most educators, distance learning represents a fun and interesting challenge for you. The logistics of dealing with multiple locations and the problem of keeping everyone interested in your topic are your main concerns. And, if the distance learning network is designed correctly, they should be your *only* concerns.

The problem is that in a large number of distance learning networks, careful attention is paid to the video side — camera locations, ability to view monitors, etc. — but little attention is paid to the audio, which carries the bulk of your message (unless you're conducting a final exam on sign language or lip reading!).

Does your distance learning network have any of these problems?

- "Hollow", boomy-sounding audio
- Feedback / squealing in the PA system
- Feedback / squealing whenever you bring a phone line into the conference

- Voices are distorted or garbled (difficult to hear or understand participants)
- Fans or blowers overpower voices
- Some voices are too faint, others too loud
- Background noise is really annoying
- Acoustic echo (you hear your own voice coming back to you, or your students hear their own voices coming back to them)
- Transmission echo (people in your distance learning network hear their voices coming back to themselves with a long delay)
- Telephone based audio: the overall sound is thin, tinny, noisy, difficult to listen to for long periods of time

***You do not have to put up with bad audio in your distance learning network!***

This paper will discuss the most common causes of the problems encountered with audio systems, and practical suggestions for correcting the problems.



# IT'S (ALMOST) ALL IN THE ACOUSTICS

Here is a bold (but true) statement: *Most audio problems in your distance learning network are caused by poor acoustics in the classrooms.*

With only a few exceptions, the majority of your problems can be traced to the hard surfaces you'll find in the classroom — walls, floors, ceiling, windows, and tables. A room with lots of parallel hard surfaces is said to be highly *reverberant*, meaning a sound introduced into the room will bounce around for some time before decaying beyond your ability to hear it. This bouncing effect creates a 'boomy' or hollow sound in the room, and you may hear echoes of your voice when you talk. This bouncing effect is also referred to as "multipath".

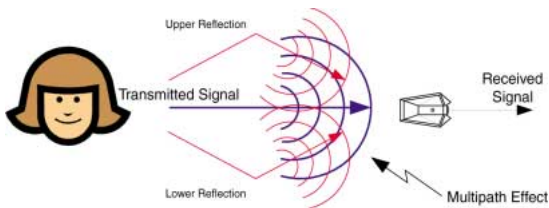

"But," you say, "we've had reverberant classrooms ever since schoolhouses were first designed. What makes them a problem in distance learning?"

Reverberant classrooms only cause minor problems for the people in them (the biggest problem being fatigue) because the position of our ears, combined with the processing power of our brains, permit us to ignore the bouncing audio and concentrate on the source of the original sound (hopefully, the teacher). In other

words, we hear three-dimensionally. A microphone, on the other hand, "hears" one-dimensionally – it simply picks up everything it "hears" and sends it to the other classrooms. The original sound is given the same treatment as a reflection of the sound because the microphone cannot differentiate between the two. The students at the other sites do not have the benefit of 3-D hearing because ALL sounds are reaching them from a single location (the loudspeaker). The result is that the students in the distant locations hear everything - original audio plus reflections - at one level (the loudspeaker's volume) which gives them distorted, garbled sound. Even when voices sound reasonably good, a reverberant room can cause a deep 'rumble' which is heard at all other sites in the network.

There are a number of ways to control reverberant rooms. The best "fix" is acoustic treatment: acoustical ceiling tiles, carpeted floors, sound-absorbing panels on the walls, and draperies over the windows. If you don't have the budget for sound panels, carpets or draperies, try tacking blankets to the walls and tossing some throw rugs on the floor. Even though this won't fix all of your problems, you'll be surprised how much "quieter" the room gets. You should invest in draperies no matter what else you do: they will dampen sound, and your video will look better without interference from sunlight.



*Making a few small changes in your room - such as rugs or curtains - can greatly reduce reverberation.*

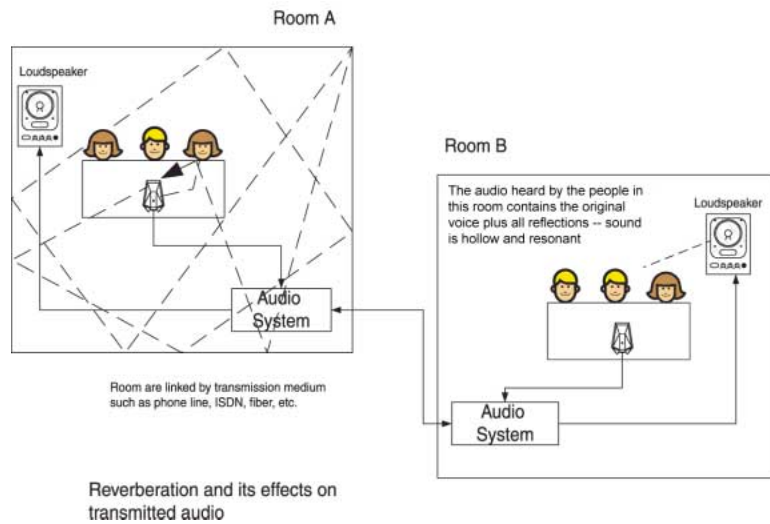

### *Reverberation in the classroom*

There are some electronic “fixes” that can help reverberant rooms:

1. An automatic (or “gated”) microphone mixer reduces the number of times reflected audio can reach a microphone by turning idle mics off (the mixer must have a “threshold” setting that sets the “on” level above the level of the reflected sounds). Even if you have acoustic treatment in the room, you may want an automatic mixer to keep background noise at a minimum. Automatic mixers will be discussed in more detail below.
2. Microphone processors can distinguish between the original voice level appearing at a microphone and lower-level reflections, and adapt to prevent the lower level audio from being passed through

the system. Mic processors can also remove background noise from the audio. (However, you must have a processor for EACH microphone in the room, which can get expensive.)

## THE ASPI DIGITAL SOLUTION

Background noise cancellers, such as those manufactured by ASPI Digital for our EchoFree® product line, are very effective in removing the ‘rumble’ that is common in reverberant rooms. People in the originating room will still hear the rumble, but it won’t be transmitted to other rooms. If you are using an automatic microphone mixer and want to control the rumble that is heard by other rooms, try installing an ASPI product in-line with your automatic mixer.

---

# CORRECT MICROPHONE USAGE

## WHY DON'T WE SOUND AS GOOD AS THE PEOPLE ON TV?



Because you can't see microphones on television programs, you might believe you don't need to place microphones close to participants in your classroom. The truth is that microphones are VERY close to announcers and actors on TV, and there are a lot of mics in use.

On most television programs, good camera angles are used to conceal boom microphones just over the actors' heads. If you look closely at a news announcer, he or she may be wearing a color-coordinated lavalier microphone. In television, great care is taken to conceal microphones because the sight of them would distract from the desired appearance of the sets and actors. This generally isn't a concern in distance learning classrooms! However, you need to make sure microphones are placed in locations where students won't hit or bump them, or where papers and books won't be put on top of the microphones.

There is another very important reason why commercial TV sounds better than your distance learning network: sound is carefully controlled in TV studios (with acoustic treatment, heavy drapes, non-parallel surfaces, etc.) and sound technicians are always on hand to make sure microphones are in the right positions. Television studios also use highly directional microphones to pick up only the desired sounds while blocking out extraneous noise.

It probably isn't practical to convert your classroom to a television studio, but you

can incorporate certain aspects of one, especially when it comes to microphone usage.

Make sure you have an adequate number of microphones in the room. If you don't have enough microphones, it will be difficult to hear everyone (some people will sound faint and far-off while others are loud). A common mistake is to try to use a small audioconferencing system in a large classroom. A few microphones simply won't do the trick when you're dealing with a large room. A good guideline is to have one microphone per 2 to 3 students (an automatic mixer is important when more than 4 microphones are used: see below).

Get microphones off of the desks and tables. Low-profile "boundary" microphones that sit on a tabletop are attractive and can work well for a corporate conference room, but in the paper-laden classroom, these microphones are bound to get covered (or rustling papers will be louder than the students' voices). Podium (or "gooseneck") microphones are a better choice for distance learning: these microphones involve a small stand mounted to the desk, and a flexible "neck" with a small microphone positioned about a foot above the table.

### What about ceiling microphones?

Ceiling microphones are attractive for classroom use because they keep mics out of students' reach, and out of the way. It is important to know, however, that as

1. Use an adequate number of microphones.
2. Get mics off desks and tables.
3. For more than four mics, use an automatic mixer.



microphones are moved away from the people who are talking, background noise becomes a huge problem. The reason is that only a portion of the speech energy actually reaches the microphone when the mic is several feet away. In order to hear what the talker is saying, microphone gain (volume) must be increased. As noted earlier in this paper, the microphone doesn't distinguish between voices and background noise – it just picks up everything it “hears”. Increased gain to pick up the voices will mean an increase in background noise as well. Another problem with increasing gain is the likelihood of feedback – some room audio systems just can't handle high microphone gain.

If you suspend microphones from the ceiling (dangling from cables or mounted on stiff rods), you can reduce some of the talker-to-mic distance and increase intelligibility. If you do this, make sure students don't have to look up in order to talk into the microphone; position the microphones a couple feet above and *in front* of the desks.

Microphones that are flush-mounted on the ceiling *can* work (and provide a nicer appearance in the classroom), but be aware of two major downfalls:

1) ceiling mounted mics are much closer to air handling systems than they are to the students, and the “whoosh” of air could overpower voices; and

2) there is a possibility of ‘mechanical coupling,’ where the mics pick up vibrations from the ceiling framework, such as people walking on the floor above you. Also, be careful to locate microphones away from loudspeakers to minimize the possibility of feedback.

### **The ASPI Digital Solution**

If you're using ceiling microphones and you're having problems with noise or feedback, ask your system integrator to install a multi-channel echo / noise canceller such as the ASPI EF1210 between the microphones and the microphone mixer. This should cancel most of the background noise and will allow you to “crank up the volume” on the mics to make voices much more intelligible.

If your classroom has more than four microphones (and it *should* unless it's a small class), you need to use an automatic microphone mixer. When a large number of microphones are on at once, especially in a reverberant room such as a classroom, the room's “gain” into the audio system can become too high. This excessive gain results in squealing or howling (feedback). Also, as mentioned earlier, an excessive number of “on” mics will increase background noise in the audio system. An ASPI Digital EF1210 will help with the noise, but you'll get even better results if you combine it with an automatic mixer.



**Look for an automatic microphone mixer that will:**

- be able to handle the number of microphones you will be using (most mixers are “expandable” or can be cascaded).
- not require a specific type of microphone - this can prove costly.
- provide an “automatic gating threshold” - this means that a microphone will only turn “on” when the sound level exceeds a pre-determined level. The smarter mixers can automatically set the gating threshold above the background noise.
- permit a “chair override” on one of the channels. This permits the instructor to take control of the mixer by simply speaking into his or her microphone.
- allow one microphone to be “always on.” If all mics turn off, that room’s audio will go away, making it sound to the other rooms as though the connection were cut off. Leaving one microphone on will provide a more natural sound and assure the other rooms that the connection hasn’t been cut.



## CORRECT LOUDSPEAKER USAGE

A common mistake in distance learning or teleconferencing classrooms is the tendency to use only one or two loudspeakers to carry the audio from the other class sites. This can result in the following problems:

- When too few loudspeakers are used, it's necessary to crank up the volume, which places the room closer to a "feedback point."
- The students near the loudspeakers are in pain from the volume, while students who are far away from them can barely hear what's going on.

Using an adequate number of loudspeakers will allow you to keep volume at a reasonable level throughout, and will minimize the amount of loudspeaker audio that is picked up by microphones. The best way to distribute loudspeakers is to place them in the ceiling (or mount them along the walls) and control them with a separate power amplifier. The

better amplification systems permit "zoning" of the loudspeakers, which is useful in lecture halls for amplifying the instructor's voice along with the audio from other sites (the loudspeakers directly above the instructor are kept at a lower volume to prevent feedback via the instructor's microphone).

One final note on loudspeaker placement: try to isolate loudspeakers from microphones as much as possible. Remember that a microphone will pick up *all* sounds in its vicinity, and audio coming out of a speaker will be treated as just another voice in the room. This can create feedback / squealing, and is one of the causes of acoustic echo (see next page).

*Make sure you use enough loudspeakers to keep the volume at a comfortable level.*



# ACOUSTIC ECHO

OR: WHY AM I HEARING MYSELF? THIS IS REALLY ANNOYING!



Anytime two or more sites talk to each other with “open” microphones and loudspeakers, the potential exists for acoustic echo. Acoustic echo is caused whenever a site’s microphones pick up received audio off loudspeakers and re-transmit the audio back to the originating site.

duced by the transmission path, will result in a delayed echo that could rival deep canyons or baseball stadiums. Unless you’re a professional sports announcer, you can become extremely unnerved by this delayed repetition of your voice.

Fortunately, it’s easy to fix acoustic echo!

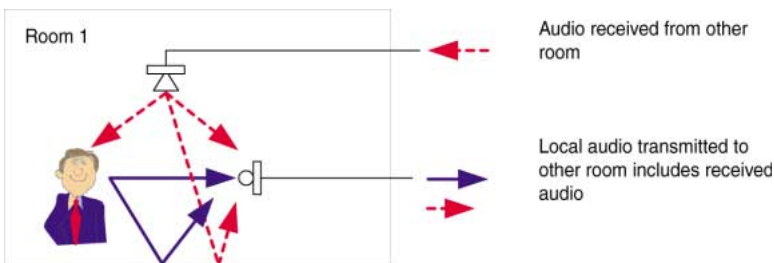

*Removing acoustic echo is easy with an acoustic echo canceller.*

The pick-up path of the audio can be direct (straight line from loudspeaker to microphones) or indirect (bouncing around the room, then hitting the mics). Depending on the size of the room, or how reverberant the room is (reverberant rooms bounce the audio around for quite a while), a certain amount of delay will occur between the time the audio appears on the loudspeakers and when it reaches the microphones. This “room delay,” combined with any delays intro-

All it takes is a product called an acoustic echo canceller (AEC). The AEC is a bi-directional device which is placed into a room’s sound system between the microphone mixer and transmission system, and the receive port and loudspeaker system.

Acoustic echo cancellers use digital signal processing (DSP) technology to compare received audio with the audio being sent back down the transmission system. Any

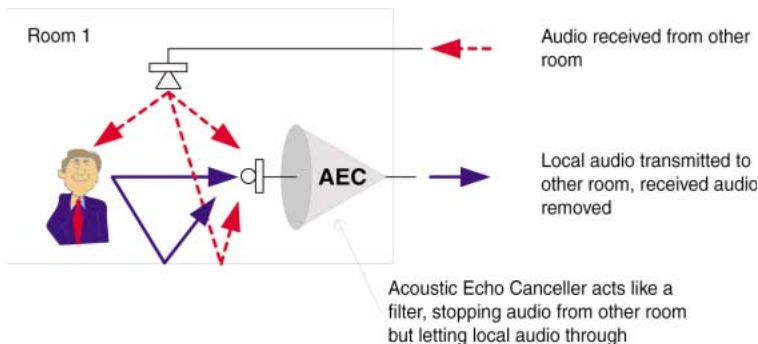



audio that has the same characteristics as the received audio is removed from the transmitted signal. Recent advancements in AEC technology have made these devices very effective in removing both “real-time” and delayed echoes.

*An important note: an AEC in your room will do nothing to keep you from hearing the return of your own voice, because an AEC benefits the OTHER site(s) by removing their audio from the audio being sent to them. In order to eliminate acoustic echo at all sites, you will need to place an AEC at each location in the distance learning network.*

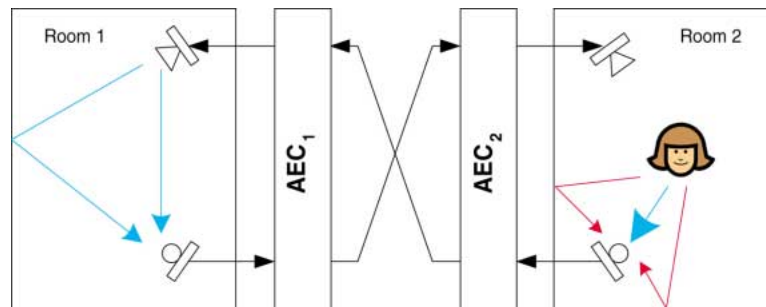

When shopping for an acoustic echo canceller, look for the following features:

- Automatic adaptation to room conditions (some older AEC's must use a loud, long burst of noise to “train” the AEC to the room)
- A “tail time” (echo cancellation span) that is sufficient for the size of your room, taking into account both loudspeaker-to-mic distance and reverberation issues (if the “tail time” is not long enough, not all of the echo will be cancelled, and other rooms will hear everything from weird “blips” to full echoes)
- Constant adaptation to changing room conditions (some older AEC's freeze at a certain setting, and break into echo/feedback when people move around the room)
- FAST adaptation to the room. This is called “convergence rate” – the faster the AEC adapts, the better.

### The ASPI Digital Solution

All ASPI Digital AECs feature very fast convergence rate – currently the best in the industry – along with automatic and constant adaptation, and a “tail time” that is sufficient for even large training rooms. Plus, we're the only company to include background noise cancellation in our AECs.

# ACOUSTIC ECHO CANCELLATION BETWEEN ROOMS

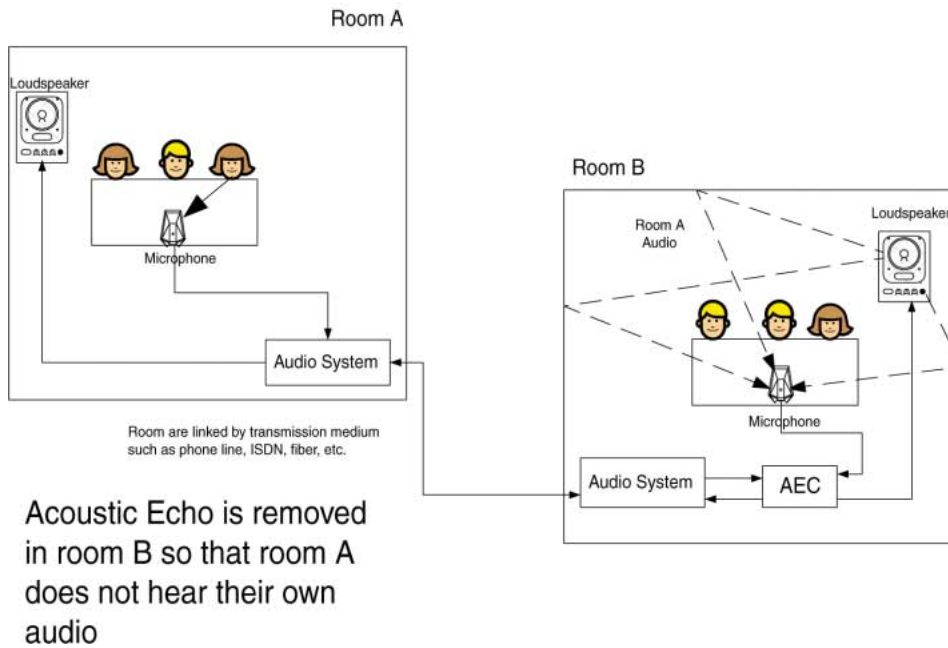
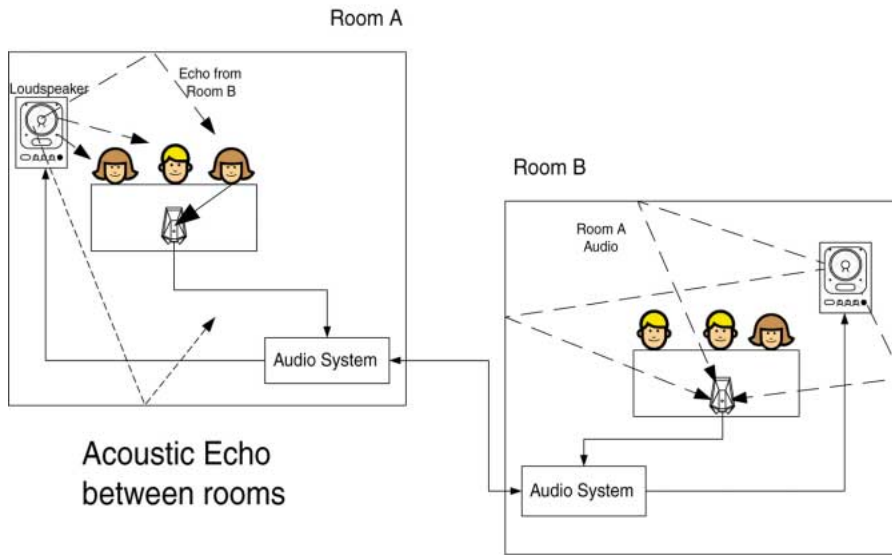



## MORE ON BACKGROUND NOISE

One of the most distracting things in a distance learning network (or any type of multi-site electronic meeting) is the extraneous noise that is picked up by microphones and sent to the other sites. In addition to the rumble or “boomy” sounds caused by room reverberation, there are several other types of noise to be considered:

- HVAC / air handling systems
- Fans on computers, overhead projectors, etc.
- Buzz from fluorescent lighting
- Noises coming into the room from outside (talking, vacuum cleaners, traffic noise, etc.)
- Papers shuffling / rattling in front of microphones

Some of these problems aren't fixed easily. You may need to ask the building contractor to install quieter air handling systems or bring in an electrical contractor to change the lighting system. Be careful where you place microphones – a mic right next to an overhead projector fan or computer will pick up almost nothing but fan noise. As for noises coming in from the hallway, one suggestion is to buy an “ON AIR - QUIET PLEASE” light and install it next to the classroom door in the hallway. (If your integrator does not have one of these lights, it can be purchased through a broadcast equipment dealer.) Traffic noises can be dampened somewhat with heavy curtains and other acoustic treatment (see section II).

### The ASPI Digital Solution

All products in ASPI's EchoFree® line incorporate background noise cancellation. This patent-pending technology helps to reduce the problems caused by microphone pick-up of fans, blowers and other constant noises. It isn't a cure-all, though – please try to keep those mics away from the projector fans if you can.

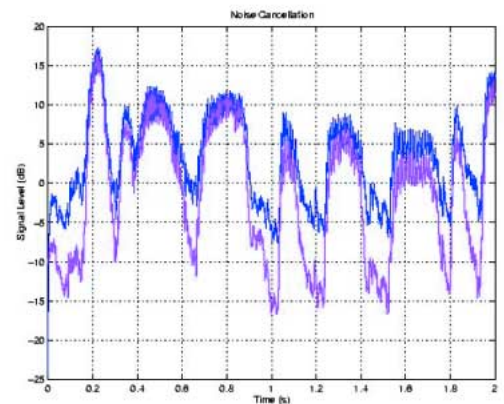

*ASPI's Noise Cancellation Algorithm (patent pending) dramatically reduces the level of ambient noise that is sent to other locations.*

---

# SATELLITE AND TRANSMISSION ECHO



Whether your distance learning network is using satellite delivery or MCU / land based systems, you can introduce significant echo problems even when you have taken steps to eliminate acoustic echo at each of the sites.

There are three ways that transmission echo can be created:

1. Satellite delivery with telephone call-ins (see Figure A, page 14)

In this type of transmission (typically used in business television or distance learning networks that span huge distances), master video and audio are sent to the remote classrooms by satellite. To ask questions or respond to the teacher, the remote classrooms call in to the master facility via telephone. So that all other classrooms can hear the question or response from a remote classroom, the audio from that room is uplinked to the satellite. The problem with this is that the classroom originating the question ALSO hears that audio, and it has been delayed considerably because of the satellite delay. This is not the same thing as acoustic echo, because this audio is intentionally mixed into the master feed.

2. "Loop-back" of audio (see Figure B, page 15)

Even when satellite delivery is not used, redistribution of audio in multipoint networks creates a similar problem. Because all sites in an MCU based network are always "on" audio-wise and the feed is multipoint-to-multipoint, each site will

hear their own audio looped back to them. Again, this is an intentional mix, not accidental pick-up of audio via loudspeakers. The delay may not be as long as that experienced via satellite, but the loop-back of a classroom's audio at full volume can create significant feedback and howling problems.

3. "Copies" of audio caused by different types of equipment (see Figure C, page 15)

An interesting problem occurs when older CODECS are used in the same multipoint network as newer, faster equipment. The new equipment (using fiber optic or T1 transmission) sends the signal to other sites very quickly. When an older CODEC, such as an ISDN-based product, is introduced into the network, it sends out its signal (which includes that room plus all other sites) at a slower speed. The result is that the rooms with newer equipment will hear two copies of the same audio – transmissions from the other fast equipment plus the transmission from the slower equipment.

Until recently, there has not been a satisfactory "fix" for these problems. Satellite and loopback echo have been somewhat controlled by using push to talk systems, which mute the incoming audio in the remote room until the student has finished speaking. These systems typically place a "hold" on the mute for about a second after the student stops speaking so that the "tail" of the echo does not reach the classroom. The problem is that the "tail" mute often cuts off the first few words of



the instructor's response as well. In order for all sites to hear the full response, the instructor must learn to delay his or her response by a couple seconds, which can lend an awkward feeling to the session and reduce the natural flow of conversation.

No "fix" at all existed for the "copies of audio" problem... until now.

### The ASPI Digital Solution (see Figure D, page 16)

In early 2000, ASPI Digital introduced a product called the EF1210TEC (Transmission Echo Canceller) which incorporates multi-channel acoustic echo and noise cancellation along with up to two seconds of transmission echo cancellation. This product is placed at each remote site in the distance learning network and can handle echoes that have been delayed up to two seconds by the network transmission system. The EF1210TEC can be set up to handle either looped-back audio or copied audio.

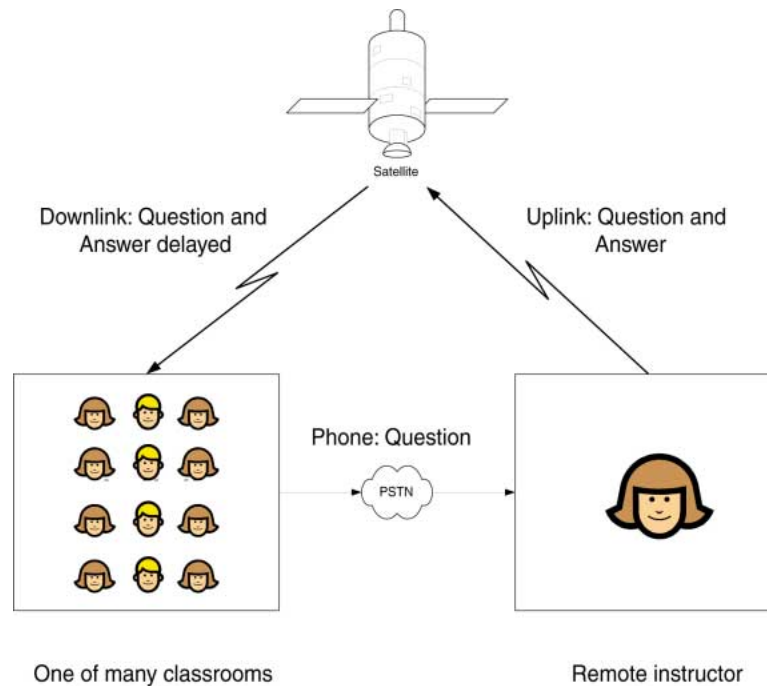

Transmission Echo Figure A - Satellite Echo

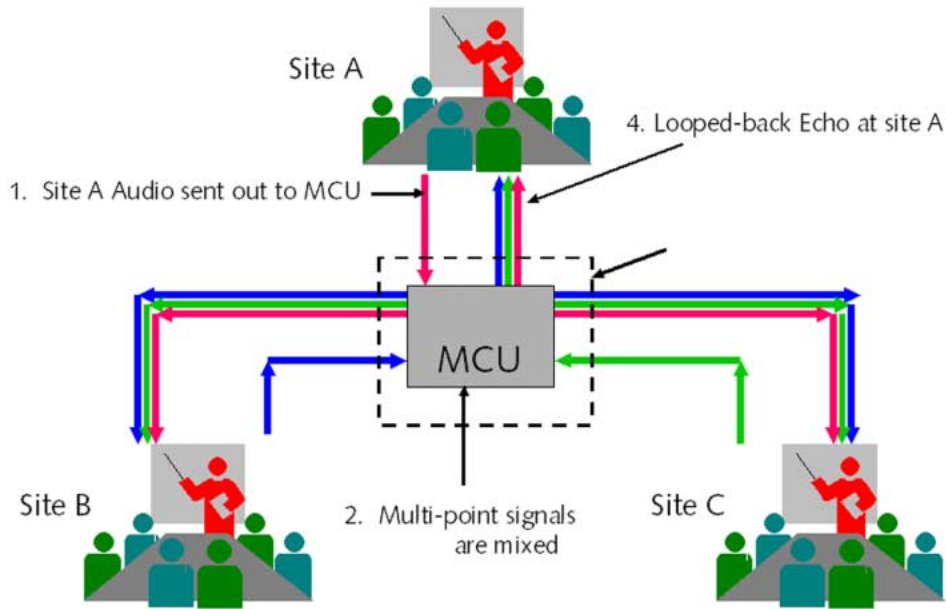

Transmission Echo Figure B - "Loop-Back" echo

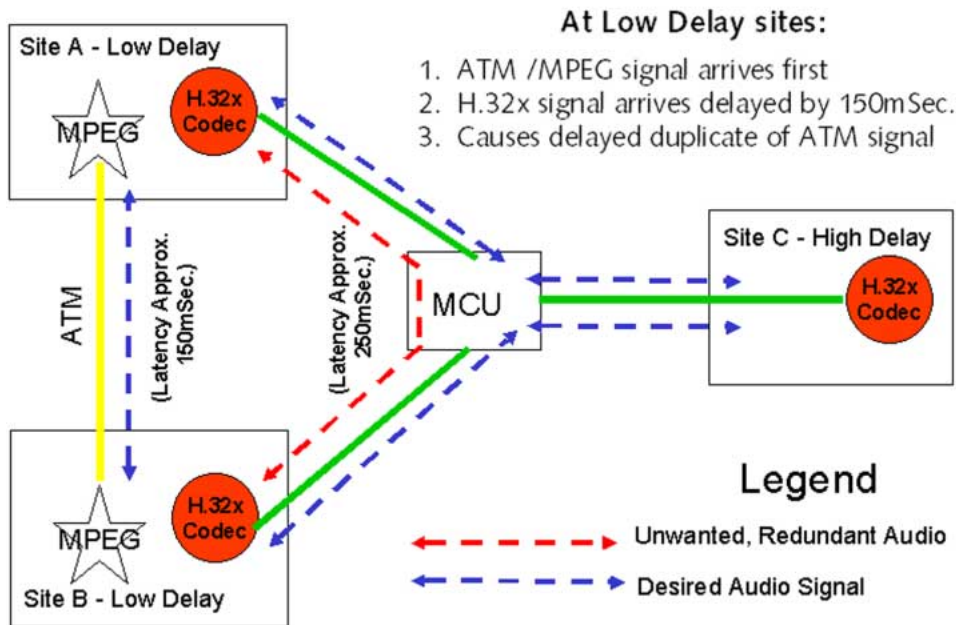

Transmission Echo Figure C - Echo caused by copies of the same signal



Duplicated

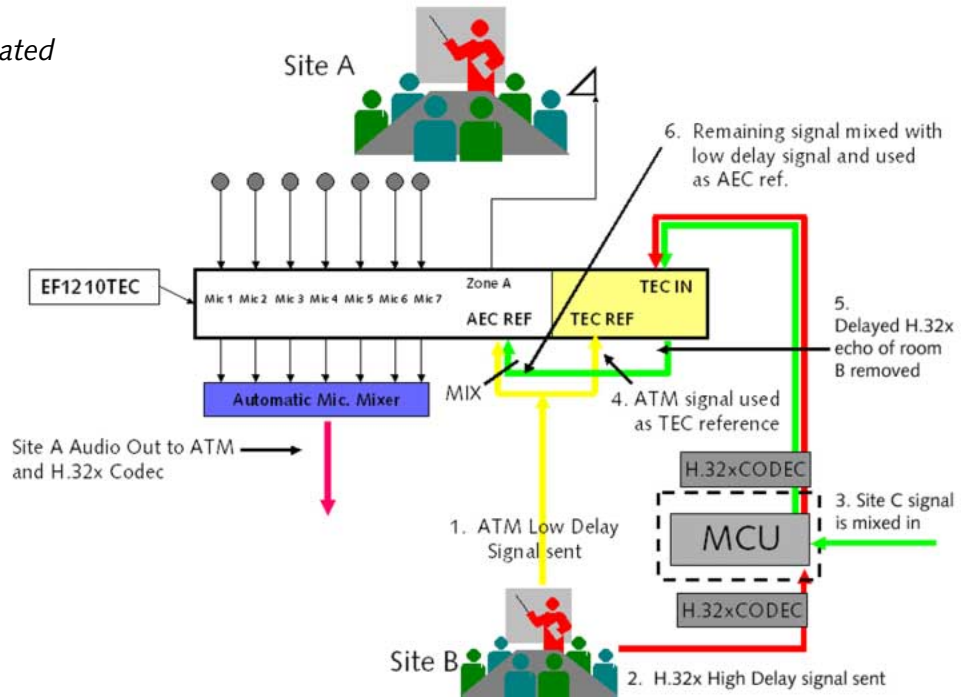

Looped-Back

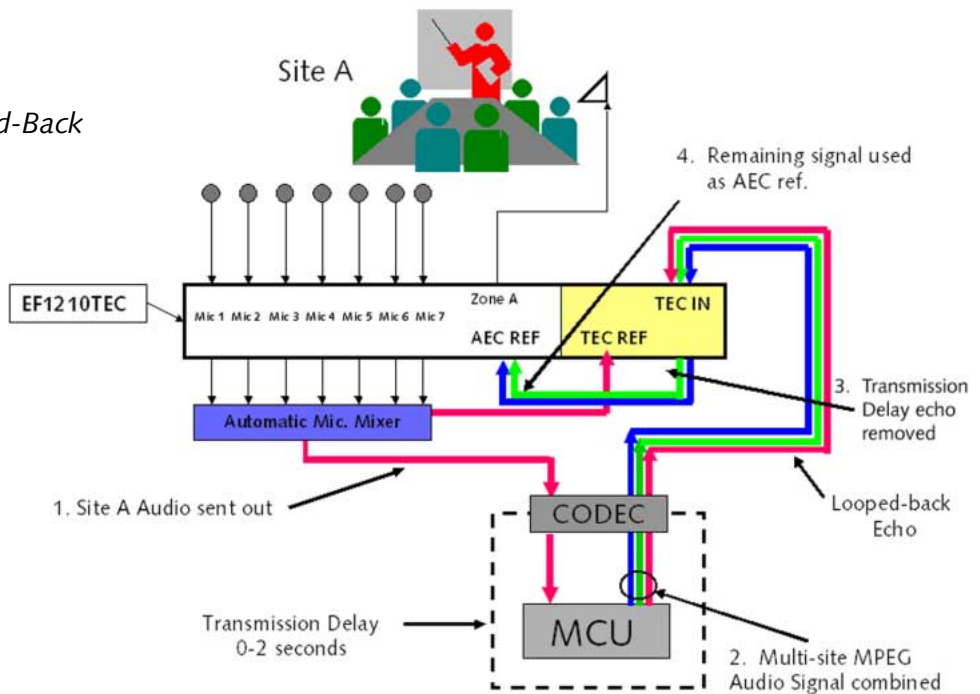

Transmission Echo Figure D - ASPI Digital's EF1210TEC can remove duplicated audio or looped-back audio from your distance learning network.



# SOUND SYSTEM PROBLEMS

## (SQUEALING / HOWLING)



When a sound system starts squealing or howling, it is said to be in a **feedback state**. Feedback is caused by either an electronic or acoustic signal “feeding back” to its source, becoming amplified, and going through the cycle again.

- Electronic feedback is caused when an “output” signal is erroneously routed back to the sound system’s input. This can also be caused by improperly adjusted telephone equipment (see next section).
- Acoustic feedback is caused by having microphones too close to the loudspeakers that carry the microphone audio (local sound reinforcement).

Acoustic feedback can also be caused when the “gain” of the audio system is too high. Frequently, if the other rooms can’t hear your room, it is because the microphones are too far away from the talkers. The answer is to turn up the gain on the microphones so they’ll pick up the voices more easily. The problem with

turning up the gain is that many acoustic echo cancellers can’t handle an increase in gain, and they’ll break into feedback.

The electronic feedback problem can be fixed through proper wiring of the sound system or replacing telephone equipment that may be causing the feedback. Ask your system integrator or consultant for assistance.

### The ASPI Digital Solution

If your system is breaking into feedback whenever you increase the gain on the microphones, chances are your acoustic echo canceller isn’t robust enough to handle the higher volume. We suggest you try installing an ASPI Digital EF1210 between your microphones and mic mixer. The EF1210 is designed to handle much higher room gain than competing products. Plus, it’ll cancel the background noise that inevitably comes up when volume is increased.



# TELEPHONE CALLS AND TELEPHONE CONFERENCING PROBLEMS

If your sound system starts squealing or howling whenever a phone call is introduced, the problem is not in the sound system but in the *interface* to the phone line. Most often, the wrong device has been used for bringing the phone call into the audio system. Telephone “couplers,” devices normally costing \$300 or less, simply will not work for your application because they cannot adequately isolate the two sides of the telephone call. This inadequate isolation results in ‘bleedthrough’ of audio from the “send” side of the coupler to the “receive” side, and when this audio is amplified through your sound system, electronic feedback results.

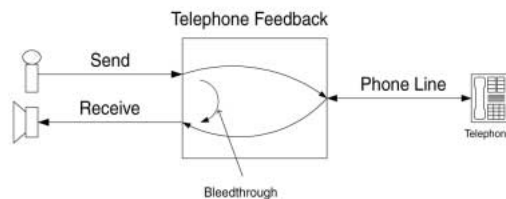

Luckily, phone coupler problems are also easy to resolve. Throw out the couplers and replace them with “digital telephone hybrids” or “digital phone-adds”, available through your systems integrator or a broadcast equipment dealer. These devices are the same products used at radio and TV stations to bring callers into talk shows. They are considerably more expensive than the couplers (they cost

about \$800 on the low end and \$2500 on the high end) but won’t introduce feedback into your audio system.

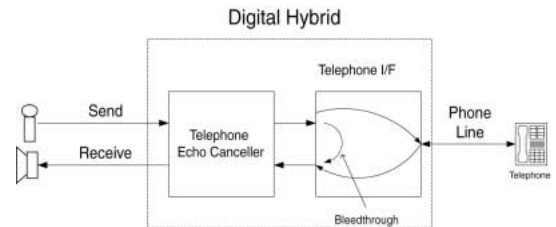

There is only one “trick” to using telephone hybrids: the audio sent down the telephone line cannot contain any of the caller’s own audio or feedback will result. You need to use what is called a “mix-minus” feed to the caller, which is a mix of all of the audio in your system *minus* the caller’s audio. Conferencing phone-add products, such as the ASPI Digital EF200, have been designed to work with the echo canceller so that this problem is eliminated. However, if your system is complex and involves mixing of a number of audio sources, you may need to have your integrator create a “sub-mix” or “clean feed” to send to the callers on the phone line.

## OTHER TELEPHONE SYSTEM CONCERNS

If your distance learning network is an audio-only system based on standard



phone lines (rather than digital or satellite transmission), a significant problem can detract from the efficiency of your class: listener fatigue. Simply put, when you listen to a phone call for a long time, your brain has to work overtime just to process out the line noise and compensate for the thin, "tinny" sound of the line.

The best cure for phone line quality is to upgrade your distance learning network to another transmission system such as ISDN, ATM, or fiber optic. These systems offer higher "bandwidth," meaning voices sound natural, and transmission noise is eliminated because digital technology is employed. If your budget does not permit an upgrade of this type, you should at least try to maximize your system through the use of digital telephone hybrids combined with microphones, loudspeakers, and acoustic echo cancellers each site. Also, when looking for a digital telephone hybrid (or "phone add"), try to find one that incorporates background noise cancellation (such as the ASPI Digital EF200). This will remove the hiss that makes phone calls so hard on the ears.



## SUMMARY

Yes, it is hard to achieve good sounding audio in distance learning networks. There are many obstacles beginning with the room acoustics, continuing with the electronics, and ending with user technique (speaking directly into microphones and learning the etiquette of multi-site operation). However, audio problems are not insurmountable. Once your audio system has been correctly "tuned," you will find a dramatic increase in productivity and enjoyment.

### ABOUT ASPI DIGITAL

Since 1981, ASPI Digital has specialized in the development of digital signal processing (DSP) products for voice and audio. ASPI's vision is to enhance the way people communicate by building innovative DSP sound products. ASPI understands that audio is critically important to the total audio / videoconference experience. ASPI is using its expertise in audio and DSP to develop high-quality, room based audio systems for the A/V and sound contractor markets. ASPI's EchoFree® products allow users to experience "full-duplex" communication in situations never before thought possible, such as distance learning, telemedicine and courtroom applications.



1720 Peachtree St. NW  
Suite 220  
Atlanta, GA 30309  
Toll-Free (North America):  
800-932-2774  
404-892-3200  
404-892-2512 fax  
[www.aspi.com](http://www.aspi.com)

*The ASPI Digital Logo, The Sound of DSP and EchoFree are registered trademarks of ASPI Digital.*